

Industrial air cooler DVS

Cooling and working rooms

Cu/Al - R404A

GEA Heat Exchangers



Goedhart



Goedhart DVS

The Goedhart DVS range of dual discharge ceiling mounted air coolers consists of 162 types with capacities between 3,1 and 151.7 kW. The aircoolers are especially suitable for cooling and working room applications. The height of the aircooler is low, so the maximum space in the chill room can be utilised. The coil block is standard build from aluminium end plates, copper tubes and aluminium fins. The fans are arranged for blow-through or draw-through air configuration (please state which is required when ordering). The modular design incorporates 5 different sizes of fan, with model options of up to 6 fans per cooler.

Type description

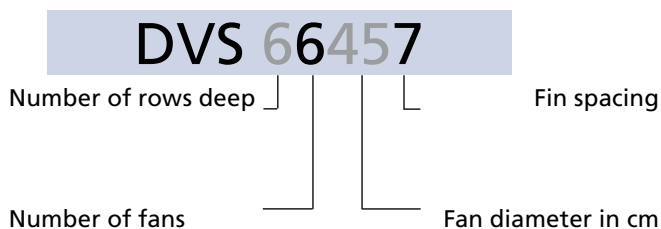

Coil execution

- Tube pitch : 50x50 mm straight
- Fin spacings : 4, 7, 10 mm
- Material : 15 mm o.d. copper tubes
- : aluminium HT-fins
- Goedhart DVS coil blocks have copper tubes mechanically expanded into fully collared aluminium fins, providing excellent thermal contact. All evaporator coils are pressure tested to 30 bars (lower by coolants) and supplied with a light overpressure charge.
- The coolers are suitable for the most commonly used refrigerants/coolants with the exception of NH3.

Casing

- Construction for ceiling mounting
- Casing material of galvanized sheet steel
- Finishing is standard white epoxy spray (RAL 9003)
- Bend/header protection by end covers, easy removed for maintenance
- 2 Hinged drip trays underneath each coil block.
- Defrost by hot gas spiral or electric defrost elements will be fixed to the bottom side of the coil.

General range features

Capacity

The listed nominal cooling capacities are based on R404A, DT1 and DTM and a RH of 85%.

Influence of coating on capacity

The use of coated fins, or of a fully coated coil will result in a capacity decrease of approximately 3%

Capacity optimisation

Since Goedhart tries to limit stock products, we are capable of optimising the circuitry of our evaporators. In order to do this, the following information is needed :

- Design capacity
- Air volume
- Refrigerant
- Air on temperature
- Evaporating temperature
- Liquid temperature before expansion valve.

Sound data

The mean sound pressure (LpA @ 3m ± 2 dB (A)) each air cooler is a calculated indication value according to the EN13487 standard parallel pipe. Goedhart uses the fan manufacturer's sound power level (LwA) at the inlet side of the fan. Changes to or by the fan or the product, affect the sound, in these cases, consult the manufacturer for the new indication value. In critical sound requirements, we advise you to consult an expert.

Defrost systems

For room temperatures where ice-build up can be expected and where the coil can not be defrosted by the room air, electric or hot gas defrost is necessary

Electrical defrost

On request Goedhart DVS can be provided with electrical defrost. The stainless steel heating elements are fitted in the coil block within aluminium tubes, which forms a highly conductive medium between the heaters and the fins. In the drip tray heater elements are fitted to the underside of the aluminium inner tray. The elements are rated for 220/240 V and are connected (IP55) for 380/415 V (with neutral) supply. The heater elements in the coil block are removable from the bend side, whilst the tray heater elements can be removed once the outer tray has been removed.

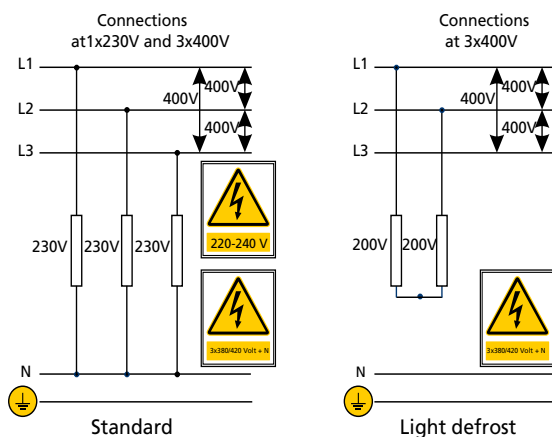

Hot gas defrost

The coil block is suited for hot gas defrost (hot gas supply through the suction header). The drip tray can be provided with a copper hot gas spiral. This is enclosed in aluminium profiles that are rigidly secured to the under side of the aluminium inner drip tray

Accessories:

Standard accessories for the Goedhart DVS aircoolers are:

- electric, hotgas defrost system.
- insulation in the space between the inner and outer drip tray.
- insulated hygienic polyester drip tray.
- insulated fanplate
- hinged fan plate
- single phase motors

The accessories are included in the price list.

Optional extras:

Various optional extras for the Goedhart DVS are available, price and delivery upon request:

- insulation discs
- 60 Hz motors
- water defrost system
- glycol/water/etc. cooling mediums
- stainless steel casing
- other fin spacings
- other fans (when external pressure is requested)

Mounting and Maintenance

Goedhart DVS is delivered on a wooden frame. When on the frame, Goedhart DVS can be handled by forklift truck, which makes positioning and installation simple. Refer to our maintenance and installation manual.

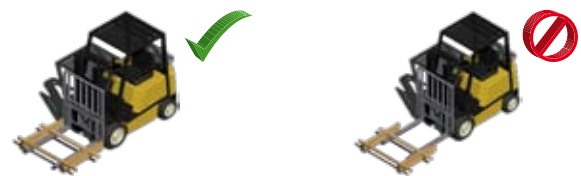

Fans

The manufacturer of the fans is Süd Electric (we reserve the right to alter the manufacturer). The fans have glass fibre reinforced polypropylene impellers. The motors are available for 400V-50Hz-3 phase or 230V-50Hz-1 phase electrical supply. 2-Speed regulation can be achieved at 400/690V-50Hz-3 phase by using a D-Y reconnection (fig. 1). 3 Phase motors are suitable for a frequency controller (A sinus filter is needed, fig. 2). 1 Phase motors are suitable for phase control and transformer. The motors are standard executed with a thermo contact. The fans are suitable for operation in air temperature applications between -40 oC and +45 oC. When the air temperature is lower then -40 °C , special fans are needed. These speciale fans have a longer delivery time. The technical data in the table below are the same as on the motor name plates and is valid for an air temperature of +40 °C.

For air temperatures lower then +40 oC, the current amperage can be calculated by using the diagram multiplication factor, suitable thermal overloads can then be selected.

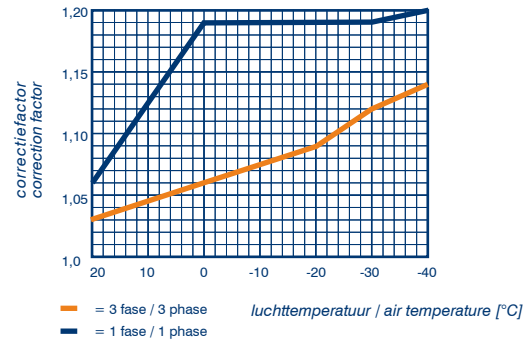

Three phase - 50 Hz

Fan type	Δ					Y			Protection class*	Fan heating
	Tension	Speed	Input	FLC	Sound power indication each fan LwA (+/-2dB(A))	Speed	Input	FLC		
	V	min ⁻¹	Watt	A	dB(A)	min ⁻¹	Watt	A		

4 pole motor (n=1500 rpm nom.)

400-32°	3x400/690	1350	250	0.60	74	1050	150	0.30	IP44	460
450-32°	3x400/690	1350	400	0.85	78	1050	300	0.50	IP44	580
500-40°	3x400/690	1380	880	1.90	85	1050	660	1.15	IP44	580
560-36°	3x400/690	1300	1250	2.30	85	1000	750	1.30	IP66	700
630-32°***	3x400/690	1300	1250	2.30	86	1000	750	1.30	IP66	820
630-28°***	3x230/400				88	1400	1400	2.50	IP66	820

6 pole motor (n=1000 rpm nom.)

400-28°	3x400/690	900	105	0.33	63	750	65	0.13	IP44	460
450-32°	3x400/690	900	180	0.40	69	750	120	0.20	IP44	580
500-40°	3x400/690	900	500	1.00	81	760	350	0.65	IP44	580
560-32°	3x400/690	880	680	1.60	75	680	400	0.90	IP66	700
630-36°	3x400/690	880	680	1.60	80	680	400	0.90	IP66	820

Single phase - 50 Hz

Ventilator type	Speed	Input	FLC	Protection class*
	min ⁻¹	Watt	A	

4 pole motor (n=1500 rpm nom.)

400-32°	1350	450	1.95	IP44
450-32°	1350	450	1.95	IP44
500-40°	1330	700	3.40	IP44
560-36°	1350	920	4.00	IP66
630-32°	1350	1300	7.10	IP66

6 pole motor (n=1000 rpm nom.)

400-28°	900	250	1.10	IP44
450-32°	900	250	1.10	IP44
500-40°	900	400	1.75	IP44
560-32°	870	700	3.40	IP66
630-36°	870	700	3.40	IP66

*= IP44 motors also available in IP66 execution (extra price)

**= Only cooling conditions

***= Only freezing conditions

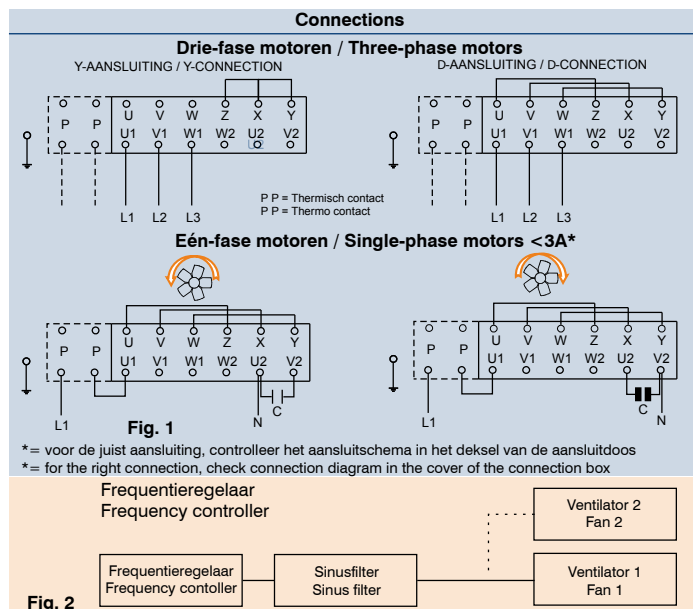

Correction factors

Capacities at DTM:

The capacities are based on R404A direct expansion and the difference between the mean air temperature and the evaporation temperature (DTM). The evaporation temperature is the saturated temperature corresponding to the pressure at the suction outlet of the cooler. The nominal capacities are based on evaporation temperatures of -5 °C, a DTM of 7 K and light frosting. Capacities for other mediums and systems are available upon request.

Correction factors for various mean air temperatures and evaporation temperatures (DTM) are as indicated in the tables below. The requested capacity must be multiplied by a correction factor from one of these tables.

$$Q_{\text{nominal}} = \text{factor} \times Q_{\text{requested}}$$

Capacities at DT1:

Hereby the capacities are based on R404A direct expansion and DT1. DT1 is the difference between air-on temperature and the evaporation temperature of the cooler. The evaporation temperature is the saturated temperature corresponding to the pressure at the suction outlet of the cooler. The nominal capacities are based on evaporation temperatures of -8 °C and DT1=8K and light frosting. Capacities for other mediums and systems are available upon request.

Correction factors for various air-on temperatures and temperature differences (DT1) are as indicated in the table below. The requested capacity must be multiplied by a correction factor from the table, so that a cooler with the resulting nominal capacity can be chosen from the selection tables.

$$Q_{\text{nominal}} = \text{factor} \times Q_{\text{requested}}$$

R404A light frost = 0.2 mm RH = 85%

DTM K	Evaporation temperature (°C)						
	0	-2,5	-5	-7,5	-10	-12,5	-15
6	1.20	1.23	1.26	1.28	1.31	1.32	1.33
7	0.96	0.98	1.00	1.03	1.04	1.07	1.08
8	0.79	0.82	0.84	0.85	0.87	0.88	0.88
9	0.68	0.70	0.71	0.72	0.75	0.77	0.77
10	0.58	0.59	0.62	0.64			

Prices on request due to divergent circuits

DT1 K	Evaporation temperature (°C)						
	0	-2,5	-5	-7,5	-10	-12,5	-15
6	1.40	1.43	1.45	1.48	1.51	1.54	1.56
7	1.12	1.15	1.18	1.20	1.22	1.24	1.25
8	0.93	0.95	0.97	1.00	1.01	1.03	1.05
9	0.78	0.81	0.83	0.85	0.87	0.88	0.89
10	0.68	0.70	0.72	0.74	0.75	0.76	0.78
11	0.60	0.62	0.63	0.65			

Prices on request due to divergent circuits

 = calculated without frosting

 = calculated without frosting

R404A normal frost = 0.5 mm RH= 85%

DTM K	Evaporation temperature (°C)						
	0	-2,5	-5	-7,5	-10	-12,5	-15
6		1.37	1.41	1.43	1.46	1.47	1.49
7		1.10	1.13	1.15	1.17	1.19	1.20
8		0.92	0.94	0.96	0.98	0.99	1.00
9			0.80	0.82	0.83	0.84	0.88
10			0.69	0.71	0.74	0.74	0.75
11			0.62	0.63	0.64		

Prices on request due to divergent circuits

DT1 K	Evaporation temperature (°C)						
	0	-2,5	-5	-7,5	-10	-12,5	-15
6		1.57	1.59	1.62	1.64	1.67	1.69
7		1.26	1.28	1.31	1.33	1.35	1.37
8		1.05	1.07	1.09	1.11	1.13	1.14
9			0.91	0.93	0.95	0.96	0.97
10			0.79	0.81	0.82	0.84	0.85
11			0.70	0.71	0.82	0.74	0.75
12			0.62	0.64	0.65		

Prices on request due to divergent circuits

ATTENTION !!!

When making your selection, pay attention to the ratio between the airvolume and capacity. A low volume to capacity ratio results in a wide temperature drop across the coil which cause to dry out (especially on coils with a high number of rows deep).

The correction factors on this page have been calculated using a varying SHR (ratio of sensible heat load / total heat load). The chart left indicates the SHR values used in the calculations, in which dt is the difference between the air and evaporation temperatures. The SHR values have been based on entering air with a relative humidity of 85%.

Example:

- $t_o = -10$ °C and $dt = 10$ K resultant SHR value is 0.70
- $t_o = -10$ °C and $dt = 5$ K resultant SHR value is 0.82
- $t_o = -30$ °C and $dt = 10$ K resultant SHR value is 0.84
- $t_o = -30$ °C and $dt = 5$ K resultant SHR value is 0.98

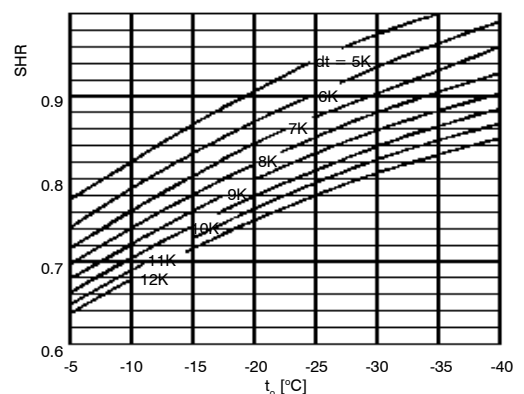

DVS 7mm Technical data

Type DVS	3x400V-50H-4pole (1500 min ⁻¹ nom.)				3x400V-50H-6pole (1000 min ⁻¹ nom.)				Surface m ²	Internally volume dm ³	Weight kg	Dimensions							Connections			
	R404A		Air volume m ³ /h	LpA @ 3 m (+/-2 dB(A))**	R404A		Air volume m ³ /h	LpA @ 3 m (+/-2 dB(A))**				L	B	H	E1	E2	E3	E4	Refrigerant		Hot gas mm	Drain NW"
	DTM = 7K Air mean = +2°C	DT1 = 8K (SC2) Air on = 0°C			DTM = 7K Air mean = +2°C	DT1 = 8K (SC2) Air on = 0°C													in	out		
	kW	kW	kW	kW	kW	kW	mm	mm				mm	mm	mm	mm	mm	mm	mm	mm	mm	mm	

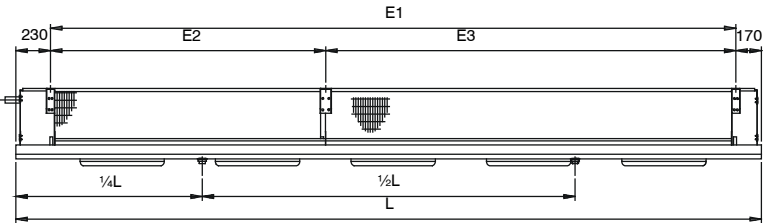
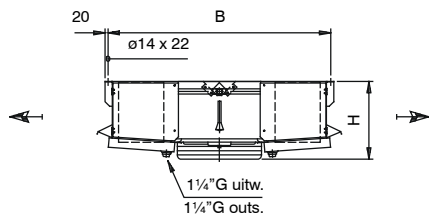

3.1.40.7	3,1	3,2	3467	52	2,4	2,3	2072	41	17	6	84	1056	1080	420	656			15	15	4x19	2x1 1/4"
4.1.40.7	4,2	4,0	3402	52	3,5	3,1	2038	41	23	6	93	1056	1180	420	656			15	15	4x19	2x1 1/4"
6.1.40.7	6,0	5,1	3271	52	4,5	3,7	1974	41	34	10	110	1056	1380	420	656			22	12	4x19	2x1 1/4"
8.1.40.7	8,0	6,3	3145	52	6,5	4,6	1919	41	46	12	128	1056	1580	420	656			22	12	4x19	2x1 1/4"
3.1.45.7	4,5	4,4	5267	56	3,9	3,7	3368	47	23	6	96	1056	1130	520	656			15	15	4x19	2x1 1/4"
4.1.45.7	5,3	5,4	5144	56	4,6	4,2	3286	47	30	8	106	1056	1230	520	656			16	12	4x19	2x1 1/4"
6.1.45.7	8,6	7,5	4915	56	7,3	5,9	3124	47	46	12	127	1056	1430	520	656			22	12	4x19	2x1 1/4"
8.1.45.7	9,8	8,2	4709	56	8,4	6,6	2973	47	61	16	148	1056	1630	520	656			22	12	4x19	2x1 1/4"
3.1.50.7	6,5	6,6	7601	63	5,3	5,3	5061	59	34	10	122	1356	1180	520	956			22	12	4x19	2x1 1/4"
4.1.50.7	8,7	8,3	7486	63	7,6	6,9	4978	59	45	12	134	1356	1280	520	956			22	12	4x19	2x1 1/4"
6.1.50.7	12,8	11,2	7263	63	11,0	9,0	4820	59	68	18	162	1356	1480	520	956			28	12	4x19	2x1 1/4"
8.1.50.7	16,6	13,5	7052	63	14,1	10,5	4672	59	91	24	190	1356	1680	520	956			28	16	4x19	2x1 1/4"
3.1.56.7	9,1	9,1	10722	63	7,9	7,5	6835	53	47	12	146	1456	1240	620	1056			22	12	4x19	2x1 1/4"
4.1.56.7	11,4	11,3	10577	63	9,2	8,4	6741	53	63	16	164	1456	1340	620	1056			22	12	4x19	2x1 1/4"
6.1.56.7	18,2	15,8	10297	63	15,1	12,3	6557	53	95	24	199	1456	1540	620	1056			28	12	4x19	2x1 1/4"
8.1.56.7	22,3	18,6	10034	63	19,1	14,5	6382	53	127	32	234	1456	1740	620	1056			35	16	4x19	2x1 1/4"
3.1.63.7	11,3	11,4	13095	63	10,0	9,8	9630	58	57	16	162	1456	1310	720	1056			28	12	4x19	2x1 1/4"
4.1.63.7	15,0	14,3	12921	63	13,1	12,2	9492	58	76	20	181	1456	1410	720	1056			28	12	4x19	2x1 1/4"
6.1.63.7	22,0	19,2	12575	63	19,1	15,8	9218	58	114	30	221	1456	1610	720	1056			35	16	4x19	2x1 1/4"
8.1.63.7	28,4	22,8	12240	63	24,5	19,1	8953	58	152	38	262	1456	1810	720	1056			35	16	4x19	2x1 1/4"

3.2.40.7	6,2	6,3	6928	55	4,8	4,6	4141	44	34	10	128	1656	1080	420	1256			22	12	4x19	2x1 1/4"
4.2.40.7	8,5	7,9	6799	55	7,0	6,2	4072	44	45	12	141	1656	1180	420	1256			22	12	4x19	2x1 1/4"
6.2.40.7	12,4	10,6	6534	55	10,1	7,9	3944	44	68	18	172	1656	1380	420	1256			22	12	4x19	2x1 1/4"
8.2.40.7	15,9	12,6	6278	55	12,9	9,1	3832	44	91	24	201	1656	1580	420	1256			28	16	4x19	2x1 1/4"
3.2.45.7	8,9	8,8	10527	59	7,7	7,3	6731	50	45	12	143	1656	1130	520	1256			22	12	4x19	2x1 1/4"
4.2.45.7	10,6	10,7	10279	59	9,1	8,3	6565	50	61	16	160	1656	1230	520	1256			22	12	4x19	2x1 1/4"
6.2.45.7	17,1	15,1	9819	59	14,5	11,8	6238	50	91	24	196	1656	1430	520	1256			28	16	4x19	2x1 1/4"
8.2.45.7	19,5	16,3	9403	59	16,8	13,2	5936	50	122	30	231	1656	1630	520	1256			28	16	4x19	2x1 1/4"
3.2.50.7	13,4	13,3	15196	66	11,6	11,0	10118	62	68	18	196	2256	1180	520	1856			28	12	4x19	2x1 1/4"
4.2.50.7	17,7	16,7	14966	66	15,2	13,7	9950	62	91	24	220	2256	1280	520	1856			28	16	4x19	2x1 1/4"
6.2.50.7	25,9	22,4	14519	66	22,0	18,0	9633	62	137	34	268	2256	1480	520	1856			35	16	4x19	2x1 1/4"
8.2.50.7	33,4	27,0	14093	66	28,1	20,9	9336	62	182	46	317	2256	1680	520	1856			35	16	4x19	2x1 1/4"
3.2.56.7	18,8	18,9	21437	66	15,9	15,1	13666	56	95	24	236	2456	1240	620	2056			35	16	4x19	2x1 1/4"
4.2.56.7	24,2	22,7	21145	66	20,7	18,6	13477	56	126	32	267	2456	1340	620	2056			35	16	4x19	2x1 1/4"
6.2.56.7	36,2	31,6	20584	66	30,3	24,7	13109	55	190	48	330	2456	1540	620	2056			42	16	4x19	2x1 1/4"
8.2.56.7	45,8	37,4	20055	66	38,3	28,9	12754	55	253	64	393	2456	1740	620	2056			42	22	4x19	2x1 1/4"
3.2.63.7	22,7	22,8	26184	66	19,9	19,6	19255	60	114	30	263	2456	1310	720	2056			35	16	4x19	2x1 1/4"
4.2.63.7	30,0	28,7	25834	66	26,4	24,3	18978	60	152	38	298	2456	1410	720	2056			35	16	4x19	2x1 1/4"
6.2.63.7	43,8	38,3	25139	66	38,3	32,0	18428	60	228	58	370	2456	1610	720	2056			42	16	4x19	2x1 1/4"
8.2.63.7	56,7	45,5	24464	66	49,1	38,1	17895	60	304	76	440	2456	1810	720	2056			42	22	4x19	2x1 1/4"

3.3.45.7	13,6	13,5	15787	61	11,5	11,0	10095	52	68	18	193	2256	1130	520	1856			28	16	4x19	2x1 1/4"
4.3.45.7	17,9	16,9	15415	61	15,1	13,6	9845	51	91	24	218	2256	1230	520	1856			28	16	4x19	2x1 1/4"
6.3.45.7	26,0	22,6	14721	61	21,8	17,6	9352	51	137	34	265	2256	1430	520	1856			35	16	4x19	2x1 1/4"
8.3.45.7	33,4	27,0	14097	61	27,6	20,2	8898	51	182	46	314	2256	1630	520	1856			35	16	4x19	2x1 1/4"
3.3.50.7	19,8	19,9	22792	67	17,3	16,4	15176	63	102	26	270	3156	1180	520	2756			35	16	4x19	2x1 1/4"
4.3.50.7	25,6	24,8	22446	67	20,8	19,3	14924	63	137	34	305	3156	1280	520	2756			35	16	4x19	2x1 1/4"
6.3.50.7	38,3	33,3	21774	67	32,9	26,8	14447	63	205	52	376	3156	1480	520	2756			42	16	4x19	2x1 1/4"
8.3.50.7	48,2	38,1	21133	67	38,3	29,5	14002	63	274	68	445	3156	1680	520	2756			42	22	4x19	2x1 1/4"
3.3.56.7	28,3	27,9	32153	67	24,1	22,8	20498	57	142	36	331	3456	1240	620	3056	1028	2028	35	16	4x19	2x1 1/4"
4.3.56.7	37,5	35,8	31714	67	31,7	28,3	20214	57	190	48	375	3456	1340	620	3056	1028	2028	42	16	4x19	2x1 1/4"
6.3.56.7	54,9	47,6	30872	67	45,9	37,0	19659	57	285	72	464	3456	1540	620	3056	1028	2028	42	22	4x19	2x1 1/4"
8.3.56.7	71,0	57,2	30078	67	58,5	43,2	19128	57	380	94	555	3456	1740	620	3056	1028	2028	54	22	4x35	2x1 1/4"
3.3.63.7	34,6	34,5	39273	67	30,8	29,8	28881	62	171	44	364	3456	1310	720	3056	1028	2028	42	16	4x19	2x1 1/4"
4.3.63.7	45,3	43,3	38747	67	39,4	36,4	28465	62	228	58	416	3456	1410	720	3056	1028	2028	42	16	4x19	2x1 1/4"
6.3.63.7	67,2	58,2	37702	67	58,9	48,5	27638	62	342	86	518	3456	1610	720	3056	1028	2028	54	22	4x35	2x1 1/4"
8.3.63.7	85,6	68,2	36689	67	73,2	56,3	26834	62	456	114	622	3456	1810	720	3056	1028	2028	54	22	4x35	2x1 1/4"

Pay attention to the relation capacity / air volume !!

* Sound pressure indication (LpA) at 3 m distance each air cooler (+/- 2 dB(A)), free field conditions, according EN13487

DVS Electrical defrost

Type	Fan	Light defrost					Heavy defrost				
		Coil (230V)		Drip tray (200V)		Total	Coil (230V)		Drip tray (200V)		Total
		number	kW	number	kW	kW	number	kW	number	kW	kW



1 fan

3.1.40.f	Ø400	1 (2x)	1.26	1 (2x)	1.36	2.62	2 (2x)	2.52	1 (2x)	1.36	3.88
4.1.40.f		1 (2x)	1.26	1 (2x)	1.36	2.62	2 (2x)	2.52	1 (2x)	1.36	3.88
6.1.40.f		2 (2x)	2.52	1 (2x)	1.36	3.88	3 (2x)	3.78	1 (2x)	1.36	5.14
8.1.40.f		2 (2x)	2.52	1 (2x)	1.36	3.88	3 (2x)	3.78	1 (2x)	1.36	5.14
1.1.40.f		3 (2x)	3.78	1 (2x)	1.56	5.34	4 (2x)	5.04	1 (2x)	1.56	6.60
3.1.45.f	Ø450	2 (2x)	2.52	1 (2x)	1.36	3.88	3 (2x)	3.78	1 (2x)	1.56	5.14
4.1.45.f		2 (2x)	2.52	1 (2x)	1.36	3.88	3 (2x)	3.78	1 (2x)	1.36	5.14
6.1.45.f		2 (2x)	2.52	1 (2x)	1.36	3.88	3 (2x)	3.78	1 (2x)	1.36	5.14
8.1.45.f		2 (2x)	2.52	1 (2x)	1.36	3.88	4 (2x)	5.04	1 (2x)	1.36	6.40
1.1.45.f		3 (2x)	3.78	1 (2x)	1.56	5.34	5 (2x)	6.30	1 (2x)	1.56	7.86
3.1.50.f	Ø500	2 (2x)	3.56	1 (2x)	1.76	5.32	3 (2x)	5.34	1 (2x)	1.76	7.10
4.1.50.f		2 (2x)	3.56	1 (2x)	1.76	5.32	3 (2x)	5.34	1 (2x)	1.76	7.10
6.1.50.f		2 (2x)	3.56	1 (2x)	1.76	5.32	3 (2x)	5.34	1 (2x)	1.76	7.10
8.1.50.f		2 (2x)	3.56	1 (2x)	1.76	5.32	4 (2x)	7.12	1 (2x)	1.76	8.88
1.1.50.f		3 (2x)	5.34	1 (2x)	1.96	7.30	5 (2x)	8.90	1 (2x)	1.96	10.86
3.1.56.f	Ø560	2 (2x)	4.08	1 (2x)	1.96	6.04	3 (2x)	6.12	1 (2x)	1.96	8.08
4.1.56.f		2 (2x)	4.08	1 (2x)	1.96	6.04	3 (2x)	6.12	1 (2x)	1.96	8.08
6.1.56.f		2 (2x)	4.08	1 (2x)	1.96	6.04	3 (2x)	6.12	1 (2x)	1.96	8.08
8.1.56.f		2 (2x)	4.08	1 (2x)	1.96	6.04	4 (2x)	8.16	1 (2x)	1.96	10.12
1.1.56.f		3 (2x)	6.12	1 (2x)	2.14	8.26	5 (2x)	10.20	1 (2x)	2.14	12.34
3.1.63.f	Ø630	2 (2x)	4.08	1 (2x)	1.96	6.04	3 (2x)	6.12	1 (2x)	1.96	8.08
4.1.63.f		2 (2x)	4.08	1 (2x)	1.96	6.04	3 (2x)	6.12	1 (2x)	1.96	8.08
6.1.63.f		2 (2x)	4.08	1 (2x)	1.96	6.04	3 (2x)	6.12	1 (2x)	1.96	8.08
8.1.63.f		3 (2x)	6.12	1 (2x)	1.96	6.04	5 (2x)	10.20	1 (2x)	1.96	12.16
1.1.63.f		3 (2x)	6.12	1 (2x)	2.14	8.26	5 (2x)	10.20	1 (2x)	2.14	12.34



2 fans

3.2.40.f	Ø400	1 (2x)	2.32	1 (2x)	2.14	4.46	2 (2x)	4.64	1 (2x)	2.14	6.78
4.2.40.f		1 (2x)	2.32	1 (2x)	2.14	4.46	2 (2x)	4.64	1 (2x)	2.14	6.78
6.2.40.f		2 (2x)	4.64	1 (2x)	2.14	6.78	3 (2x)	6.96	1 (2x)	2.14	9.10
8.2.40.f		2 (2x)	4.64	1 (2x)	2.14	6.78	3 (2x)	6.96	1 (2x)	2.14	9.10
1.2.40.f		3 (2x)	6.96	1 (2x)	2.34	9.30	4 (2x)	9.28	1 (2x)	2.34	11.62
3.2.45.f	Ø450	2 (2x)	4.64	1 (2x)	2.14	6.78	3 (2x)	6.96	1 (2x)	2.14	9.10
4.2.45.f		2 (2x)	4.64	1 (2x)	2.14	6.78	3 (2x)	6.96	1 (2x)	2.14	9.10
6.2.45.f		2 (2x)	4.64	1 (2x)	2.14	6.78	3 (2x)	6.96	1 (2x)	2.14	9.10
8.2.45.f		2 (2x)	4.64	1 (2x)	2.14	6.78	4 (2x)	9.28	1 (2x)	2.14	11.42
1.2.45.f		3 (2x)	6.96	1 (2x)	2.34	9.30	5 (2x)	11.60	1 (2x)	2.34	13.94
3.2.50.f	Ø500	2 (2x)	7.24	1 (2x)	2.92	10.16	3 (2x)	10.86	1 (2x)	2.92	13.78
4.2.50.f		2 (2x)	7.24	1 (2x)	2.92	10.16	3 (2x)	10.86	1 (2x)	2.92	13.78
6.2.50.f		2 (2x)	7.24	1 (2x)	2.92	10.16	3 (2x)	10.86	1 (2x)	2.92	13.78
8.2.50.f		3 (2x)	7.24	1 (2x)	2.92	10.16	4 (2x)	14.48	1 (2x)	2.92	17.40
1.2.50.f		3 (2x)	10.86	1 (2x)	3.12	13.98	5 (2x)	18.10	1 (2x)	3.12	21.22
3.2.56.f	Ø560	2 (2x)	7.76	1 (2x)	3.34	11.10	3 (2x)	11.64	1 (2x)	3.34	14.98
4.2.56.f		2 (2x)	7.76	1 (2x)	3.34	11.10	3 (2x)	11.64	1 (2x)	3.34	14.98
6.2.56.f		2 (2x)	7.76	1 (2x)	3.34	11.10	3 (2x)	11.64	1 (2x)	3.34	14.98
8.2.56.f		3 (2x)	7.76	1 (2x)	3.34	11.10	4 (2x)	15.52	1 (2x)	3.34	18.86
1.2.56.f		3 (2x)	11.64	1 (2x)	3.52	15.16	5 (2x)	19.40	1 (2x)	3.52	22.92
3.2.63.f	Ø630	2 (2x)	7.76	1 (2x)	3.34	11.10	3 (2x)	11.64	1 (2x)	3.34	14.98
4.2.63.f		2 (2x)	7.76	1 (2x)	3.34	11.10	3 (2x)	11.64	1 (2x)	3.34	14.98
6.2.63.f		2 (2x)	7.76	1 (2x)	3.34	11.10	3 (2x)	11.64	1 (2x)	3.34	14.98
8.2.63.f		3 (2x)	11.64	1 (2x)	3.34	14.98	5 (2x)	19.40	1 (2x)	3.34	22.74
1.2.63.f		3 (2x)	11.64	1 (2x)	3.52	15.16	5 (2x)	19.40	1 (2x)	3.52	22.92



3 fans

3.3.45.f	Ø450	2 (2x)	7.24	1 (2x)	2.92	10.16	3 (2x)	10.86	1 (2x)	2.95	13.78
4.3.45.f		2 (2x)	7.24	1 (2x)	2.92	10.16	3 (2x)	10.86	1 (2x)	2.95	13.78
6.3.45.f		2 (2x)	7.24	1 (2x)	2.92	10.16	3 (2x)	10.86	1 (2x)	2.92	13.78
8.3.45.f		2 (2x)	7.24	1 (2x)	2.92	10.16	4 (2x)	14.48	1 (2x)	2.92	17.40
1.3.45.f		3 (2x)	10.86	1 (2x)	3.12	13.98	5 (2x)	18.10	1 (2x)	3.12	21.22
3.3.50.f	Ø500	4 (2x)	9.84	2 (2x)	4.28	14.12	6 (2x)	14.76	2 (2x)	4.28	19.04
4.3.50.f		4 (2x)	9.84	2 (2x)	4.28	14.12	6 (2x)	14.76	2 (2x)	4.28	19.04
6.3.50.f		4 (2x)	9.84	2 (2x)	4.28	14.12	6 (2x)	14.76	2 (2x)	4.28	19.04
8.3.50.f		4 (2x)	9.84	2 (2x)	4.28	14.12	8 (2x)	19.68	2 (2x)	4.28	23.96
1.3.50.f		6 (2x)	14.76	2 (2x)	4.28	19.04	10 (2x)	24.60	2 (2x)	4.28	28.88
3.3.56.f	Ø560	4 (2x)	10.32	2 (2x)	4.68	15.00	6 (2x)	15.48	2 (2x)	4.68	20.16
4.3.56.f		4 (2x)	10.32	2 (2x)	4.68	15.00	6 (2x)	15.48	2 (2x)	4.68	20.16
6.3.56.f		4 (2x)	10.32	2 (2x)	4.68	15.00	6 (2x)	15.48	2 (2x)	4.68	20.16
8.3.56.f		4 (2x)	10.32	2 (2x)	4.68	15.00	8 (2x)	20.64	2 (2x)	4.68	25.32
1.3.56.f		6 (2x)	15.48	2 (2x)	4.68	20.16	10 (2x)	25.80	2 (2x)	4.68	30.48
3.3.63.f	Ø630	4 (2x)	10.32	2 (2x)	4.68	15.00	6 (2x)	15.48	2 (2x)	4.68	20.16
4.3.63.f		4 (2x)	10.32	2 (2x)	4.68	15.00	6 (2x)	15.48	2 (2x)	4.68	20.16
6.3.63.f		4 (2x)	10.32	2 (2x)	4.68	15.00	6 (2x)	15.48	2 (2x)	4.68	20.16
8.3.63.f		6 (2x)	15.48	2 (2x)	4.68	20.16	10 (2x)	25.80	2 (2x)	4.68	30.48
1.3.63.f		6 (2x)	15.48	2 (2x)	4.68	20.16	10 (2x)	25.80	2 (2x)	4.68	30.48

f = fin spacing



GEA Heat Exchangers

GEA Goedhart B.V.

Nijverheidsweg 6, 4695 RC Sint Maartensdijk
the Netherlands
Phone +31 (0)166 665 665, Fax+31 (0)166 663 698
www.goedhart.nl
info.goedhart.nl@geagroup.com

GEA Heat Exchangers

GEA Goedhart s.r.o.

Kostomlátecká 180, 288 26 Nymburk
Czech Republic
Phone +420 (0)325 819 951, Fax+420 (0)325 519 952
www.goedhart.cz
goedhart.cz@geagroup.com

03.01.2.009.doc 2010-01 / Subject to modification

All offers, contracts, deliveries and other legal relations from GEA Goedhart B.V. are subject to the latest version of our general sales and delivery conditions as filed at the Chamber of Commerce in Middelburg - The Netherlands

Applicability of the general conditions put forward by any buyer is rejected explicitly by GEA Goedhart B.V.